

Megaplex Accessories Ringer-2100R, Ringer-2000, Ringer-2200N

DC Feed and Ring Power Supplies for Voice/Fax and ISDN Modules



Ringer-2100R



Ringer-2000



Ringer-2200N

- DC feed (battery) and ringing voltages for connected telephones
- Compatible with all voice/fax modules with FXS interface
- Support of E&M interfaces requiring -48 VDC
- Phantom feeding for ISDN interfaces
- Available in 3 models

DC power for
Megaplex equipped
with FXS voice
modules connected
directly to telephones

Ringer-2100R, Ringer-2000 and Ringer-2200N are DC power supplies for Megaplex voice/fax modules that require DC voltages for telephone loop-current feed (battery) and for ring signal generation. Ringers can also be the DC source for ISDN interface modules that deliver phantom power feeding.

A Ringer is needed to supply DC power for Megaplex systems equipped with FXS voice modules connected directly to telephones. Ringers provide -48 VDC "battery voltage", used by the voice modules for powering the telephones and for generating the AC telephone ring signal. In addition, Ringer-2000 can also provide -24 VDC "battery voltage".

Note: DC-powered chassis do **not** require a Ringer for most of the voice modules. For more information, refer to the relevant module data sheet and/or contact the nearest authorized RAD Partner.

E&M voice modules for direct connection to PBXs may also require a -48 VDC for certain signaling standards or long line applications (although the internal -12 VDC provided by the chassis is sufficient for most PBXs).



Ringer-2100R, Ringer-2000, Ringer-2200N

DC Feed and Ring Power Supplies for Voice/Fax and ISDN Modules

Some Ringers also provide a +60 or +72 VDC "ring voltage" output. This voltage may be required by some older FXS voice modules for conversion to an AC telephone ring signal (see the VC-4/4A/8/8A/16 module data sheet for DC requirements). AC-powered Ringer-2100R and Ringer-2000 models provide +72 VDC, while DC-powered models provide +60 VDC.

A Ringer can supply the DC voltages used for the phantom power feeding required by ISDN interfaces. Higher voltages for "U" interface phantom feeding can be created within the "U"-interface modules, by combining the various Ringer output voltages. For example, a -48 VDC "battery voltage" together with a +72 VDC "ring voltage", can be used to create 120 VDC.

RINGER-2100R PLUG-IN MODULE

The Ringer-2100R module is a 4U-high plug-in module for the Megaplex-2100 and Megaplex-4100 chassis, occupying two I/O slots. The module provides DC power for up to 32 active voice channels.

Ringer-2100R has an internal output connector, which supplies the voltages to the installed voice or ISDN modules via the internal voltage bus of the Megaplex chassis backplane, without the need for connection cables.

RINGER-2000 STANDALONE UNIT

The Ringer-2000 standalone unit provides DC power for up to 60 active voice channels. Ringer-2000 provides all DC voltages required by voice or ISDN modules: -24 or -48 VDC, as well as +60 or +72 VDC.

Ringer-2000 is a 1U-high standalone unit that can be installed in 19 inch racks. The unit has ten 3-pin DC output connectors on the rear panel for connection to multiple Megaplex units/modules. The voltage is passed from the Ringer-2000 DC output connectors via cables to the DC input connectors on the Megaplex chassis' power supply modules. See *Ordering* for cable information.

Ringer-2000 is available with several feed and ring voltage output ordering options. The Ringer-2000/48/115 and Ringer-2000/48/230 options provide only -48 VDC "battery voltage" output. These options are suitable for E&M and most FXS voice modules (which do not require +60/+72 VDC).

RINGER-2200N STANDALONE UNIT

The more powerful Ringer-2200N standalone unit provides DC power for up to 120 active voice channels (4 full E1 trunks). Ringer-2200N provides -48 VDC output for both feed and ring signals.

Optionally, a +48 VDC output is also available for creating 96 VDC if higher voltages are required by HS-U modules.

Ringer-2200N is a 1U-high standalone unit that can be installed in 19-inch racks. The regular and ISDN units feature, respectively, four or one 3-pin terminal block DC-output connectors (see *Figure 3*) on the rear panel for connection to multiple Megaplex units. The CBL-RINGER2200N-1/TB cable is available for connecting between a Ringer-2200N 3-pin TB DC-output connector and a 3-pin TB DC-input connector on Megaplex power supply modules.

To conform with both ANSI and ETSI standards, Ringer-2200N features LED indicators on both front and rear panels. Thus, the indicators are always viewable, whether the unit is mounted with the cable connectors at the front or the rear of the rack.

Note: The stated number of active voice channels that each Ringer model supports refers to the number of calls that are ongoing or ringing simultaneously. However, in most applications, not all channels are active at the same time. For example, if it is estimated that only 50% of the channels are active simultaneously, a Ringer-2100R will actually suffice to support 64 voice channels.

The number of ISDN channels that can be supported depends on the output of the Ringer model (see *Table 1*), the current required, and the actual line lengths.

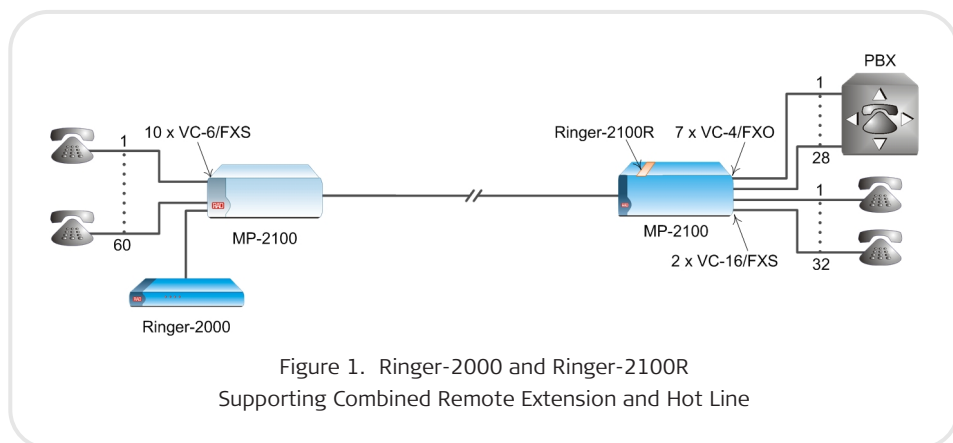

Figure 1. Ringer-2000 and Ringer-2100R Supporting Combined Remote Extension and Hot Line

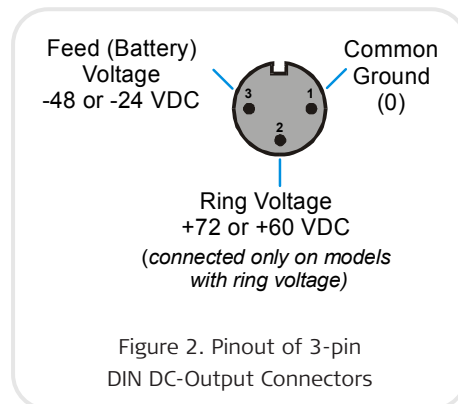

Figure 2. Pinout of 3-pin DIN DC-Output Connectors

Specifications

GENERAL

DC-Output Connectors

Ringer-2000: 10 x 3-pin female

Ringer-2200N: 4 x 3-pin TB male

Ringer-2200N/ISDN: 1 x 3-pin TB male

Ringer-2100R: internal DC connector to chassis voltage bus

See Figure 2 and Figure 3 for pinouts.

Environment

Operating temperature:

Ringer-2100R/2200N: -10°C to 55°C
(14°F to 131°F)

Ringer-2000: -0°C to 45°C
(32°F to 113°F)

Storage temperature: -20°C to +70°C
(-4°F to +158°F)

Humidity: up to 95%, non-condensing

PHYSICAL

Ringer-2100R

4U-high module occupies two I/O slots of the Megaplex chassis

Ringer-2000

Height: 44 mm (1.7 in - 1U)

Width: 480 mm (19.0 in)
(including integral rack-mount brackets)

Depth: 310 mm (12.2 in)

Weight: 2.1 kg (4.6 lb)

Ringer-2200N

Height: 44 mm (1.7 in - 1U)

Width: 430 mm (17.0 in)

Depth: 310 mm (12.2 in)

Weight: 2.1 kg (4.6 lb)

INDICATORS

Ringer-2100R, Ringer-2000

RING VOLTAGE (green) - lights when ring voltage is within the normal range



BATTERY VOLTAGE (green) - lights when feed voltage is within the normal range

Ringer-2200N

LEDs are repeated on both front and rear panels:

- 48V (green) - lights when -48 VDC output voltage is within the normal range
- +48V (green) optional - lights when +48 VDC output voltage is within normal range

Table 1. Power Specifications

	Model (according to operating voltage option)	Operating (Input) Voltage	DC (Feed) Voltage Output	Ring Voltage Output (may be required for HS-U, HS-U-6/12, HS-S modules)
	AC	115 to 230 VAC (±10%), 50/60 Hz	-48 VDC (±5%), 1.2A max	+72 VDC (±5%), 0.7A max
	-24 VDC	-24 VDC (-18 to -36 VDC)	-24 VDC (±5%), 1.2A max	+60 VDC (±5%), 0.7A max
	-48 VDC	-48 VDC (-36 to -72 VDC)	-48 VDC (±5%), 1.2A max	+60 VDC (±5%), 0.7A max
	<i>Note: Maximum combined output for Battery and Ring voltages is 65W.</i>			
	115 or 230 VAC with -24/+72 ISDN output ordering option	115 or 230 VAC (±10%), 50/60 Hz	-24 VDC (±5%), 3.0A max	+72 VDC (±5%), 0.7A max
	115 or 230 VAC with -48/+72 ISDN output ordering option	115 or 230 VAC (±10%), 50/60 Hz	-48 VDC (±5%), 3.0A max	+72 VDC (±5%), 0.7A max
	115 or 230 VAC with -48 output ordering option (no ring voltage)	115 or 230 VAC (±10%), 50/60 Hz	-48 VDC (±5%), 3.0A max	none
	-24 VDC	-24 VDC (±5%)	-24 VDC (±5%), 3.0A max	+60 VDC (±5%), 0.85A max
	-48 VDC	-48 VDC (±5%)	-48 VDC (±5%), 3.0A max	+60 VDC (±5%), 0.85A max
		115 or 230 VAC with -48 output ordering option (no ring voltage)	115 or 230 VAC (±10%), 50/60 Hz	-48 VDC (±5%), 6.0A max
115 or 230 VAC with -48/+48 ISDN output ordering option		115 or 230 VAC (±10%), 50/60 Hz	-48 VDC (±5%), 6.0A max	+48 VDC (±5%), 1.6A max

Ringer-2100R, Ringer-2000, Ringer-2200N

DC Feed and Ring Power Supplies for Voice/Fax and ISDN Modules

Ordering

STANDARD CONFIGURATIONS

- RING2000/48/72/230
- RINGER-2100R/AC
- RINGER-2200N/110
- RINGER-2200N/230

SPECIAL CONFIGURATIONS

RING2000/+/#/*

Standalone power supply unit, supports up to 60 active voice channels

Legend

+ DC battery (feed) voltage output:

- 24 -24 VDC
- 48 -48 VDC

Ring voltage output:

- 72 Ring voltage output

Note: +72 VDC is provided by AC-powered models; +60 VDC is provided by DC-powered models

* Operating (input) voltage:

- 115 115 VAC
- 230 230 VAC
- 24 -24 VDC
- 48 -48 VDC

Note: Only the following ordering option combinations are possible:

- RINGER-2000/24/72/115
- RINGER-2000/24/72/230
- RINGER-2000/24/72/24
- RINGER-2000/48/72/115
- RINGER-2000/48/72/230
- RINGER-2000/48/72/48
- RINGER-2000/48/115 (no ring voltage)
- RINGER-2000/48/230 (no ring voltage)

RINGER-2100R/^

Power supply module for Megaplex-2100 and Megaplex-4100, supports up to 32 active voice channels

Legend

^ Operating (input) voltage:

- AC 115 to 230 VAC
- 24 -24 VDC
- 48 -48 VDC

RINGER-2200N/&/~

Standalone power supply unit, supports up to 120 active voice channels

Legend

& Operating (input) voltage:

- 110 110 VAC
- 230 230 VAC

~ ISDN option for +48 VDC (Default is for -48 VDC only):

- ISDN ISDN for both +48 VDC and -48 VDC outputs

SUPPLIED ACCESSORIES

AC power cord

3-wire open-ended cable (ISDN option only)

KM-2004/RM

Hardware for mounting the Ringer-2000 unit in a 19-inch rack

RING-2200-RM

Hardware kit for mounting the Ringer-2200N unit into a 19-inch rack

OPTIONAL ACCESSORIES

CBL-RINGER-1/TB

Cable for connecting a Ringer-2000 3-pin DC-output DIN (circular) connector to a 3-pin TB Megaplex DC-input connector

CBL-RINGER2200N-1/TB

Cable for connecting a Ringer-2200N TB DC-output connector to a 3-pin TB Megaplex DC-input connector

CBL-RINGER2200N-2/TB

Cable for connecting a Ringer-2200N TB DC-output connector to two Megaplex chassis

264-123-06/11 Specifications are subject to change without prior notice. © 1988-2011 RAD Data Communications Ltd. The RAD name, logo, logo type, and the terms EtherAccess, TDMoIP and TDMoIP Driven, and the product names Optimix and Irmux are registered trademarks of RAD Data Communications Ltd. All other trademarks are the property of their respective holders.

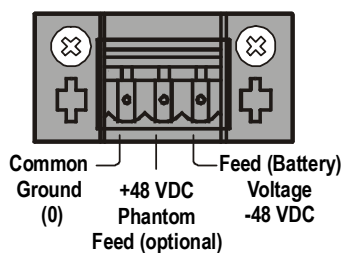

Figure 3. Pinout of 3-pin TB DC-Output Connectors

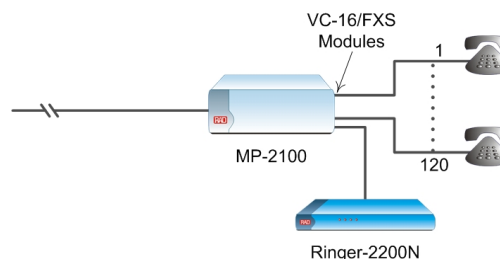

Figure 4. Ringer-2200N Supporting a Full MP-2100 Chassis with 120 VC-16/FXS Voice Channels

International Headquarters
 24 Raoul Wallenberg Street
 Tel Aviv 69719, Israel
 Tel. 972-3-6458181
 Fax 972-3-6498250, 6474436
 E-mail market@rad.com



12 avenue des prés
 78059 St Quentin en Yvelines
 Tel: 33 (0)1 77 55 03 00
 Fax: 33 (0)1 30 44 11 95
 E-mail: sales@cbnetworks.fr



data communications
 The Access Company